

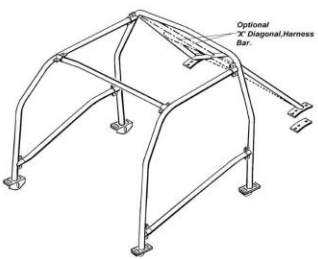

Make	Model	Part number	Description	Euro
FORD	Anglia 105e	F 006	6 point bolt-in cage. Clears normal trim and dashboard. Mounts in 6 places to the floor and rear wheel arches. MSA/FIA homologated.	
		RBF006 3SSS	Front cage	€ 226,83
		RBF006 5SSS	Rear cage, single fixed diagonal	€ 310,10
		RBF006 5SXS	Rear cage, cross diagonal and harness bar	€ 440,10
		RB00A1	Universal door bar (1 required per side)	€ 65,00
				
More information				
FORD	Capri Mk1	F 007	6 point bolt-in cage. Clears normal trim and dashboard. Mounts to the floor and rear wheel arches. MSA/FIA homologated.	
		RBF007 3SSS	Front cage	€ 242,66
		RBF007 5SSS	Rear cage, single fixed diagonal	€ 356,73
		RBF007 5SXS	Rear cage, cross diagonal and harness bar	€ 486,73
		RB00A1	Universal door bar (1 required per side)	€ 65,00
				
More information				
FORD	Capri MK1, with sunroof	F 009	6 point bolt-in cage to clear normal trim and dashboard. Mounts to the floor and rear wheel arches. MSA/FIA homologated.	
		RBF009 3SSS	Front cage	€ 254,14
		RBF009 5SSS	Rear cage, single fixed diagonal	€ 358,62
		RBF009 5SXS	Rear cage, cross diagonal and harness bar	€ 488,62
		RB00A1	Universal door bar (1 required per side)	€ 65,00
				
More information				
FORD	Capri Mk2 & Capri Mk3, no sunroof	F 008	6 point bolt-in cage. Front roll cage requires slight modification of dashboard on driver's side. Mounts to the floor and rear wheel arches. MSA/FIA homologated.	
		RBF008 3SSS	Front cage	€ 254,14
		RBF008 5SSS	Rear cage, single fixed diagonal	€ 358,62
		RBF008 5SXS	Rear cage, cross diagonal with harness bar	€ 498,62
		RB00A1	Universal door bar (1 required per side)	€ 65,00
				
More information				

Make	Model	Part number	Description	Euro
FORD	Capri Mk2 & Capri Mk3, with sunroof 	F 010	6 point bolt-in cage. Front roll cage requires slight modification of dashboard on driver's side. Mounts to the floor and rear wheel arches. MSA/FIA homologated.	
		RBF010 3SSS	Front cage	€ 254,00
		RBF010 5SSS	Rear cage, single fixed diagonal	€ 358,67
		RBF010 5SXS	Rear cage, cross diagonal and harness bar	€ 488,67
		RB00A1	Universal door bar (1 required per side)	€ 65,00
More information				
FORD	Cortina Mk1, no sunroof 	F 003	6 point bolt-in cage. Clears normal trim and dashboard. Mounts to the floor and rear wheel arches. MSA/FIA homologated.	
		RBF003 3SSS	Front cage	€ 226,83
		RBF003 5SSS	Rear cage, single fixed diagonal	€ 345,07
		RBF003 5SRS	Rear cage, single removable diagonal	€ 429,07
		RBF003 5SXS	Rear cage, cross diagonal and harness bar	€ 475,07
RB00A1	Universal door bar (1 required per side)	€ 65,00		
More information				
FORD	Cortina Mk2 	F004	6 point bolt-in cage. Clears normal trim and dashboard. Mounts to the floor and rear wheel arches. MSA/FIA homologated.	
		RBF004 3SSS	Front cage	€ 226,83
		RBF004 5SSS	Rear cage, single fixed diagonal	€ 345,07
		RBF004 5SXS	Rear cage, cross diagonal and harness bar	€ 475,07
		RB00A1	Universal door bar (1 required per side)	€ 65,00
More information				

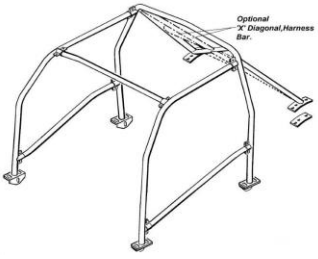
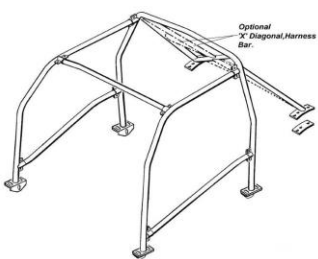
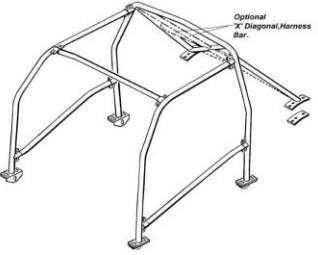
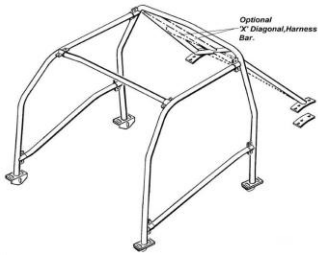
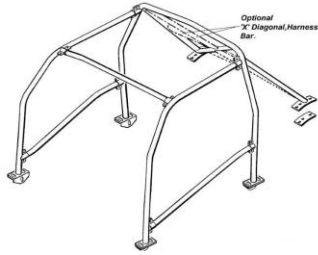
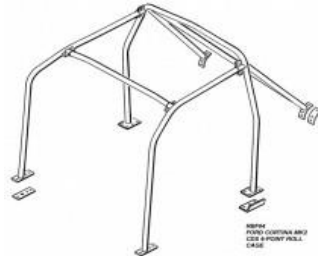
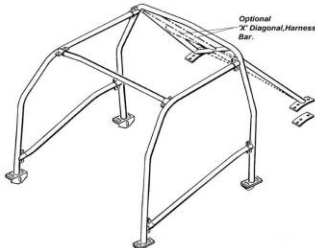
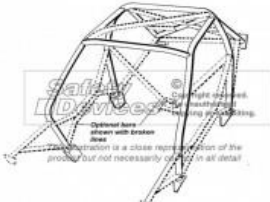
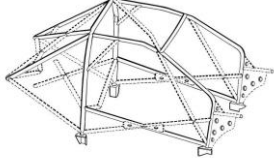
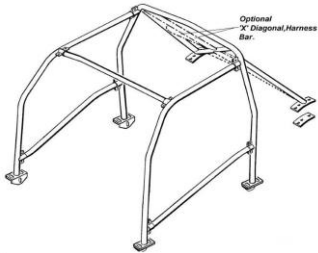

Make	Model	Part number	Description	Euro
FORD	Escort Mk1, no sunroof <i>No dash bar brackets</i> <i>No dash bar brackets</i> <i>No tunnel brace brackets</i> <i>No tunnel brace brackets</i> <i>No tunnel brace brackets</i>	F001/A (formerly F001)	6 point bolt-in cage. Clears normal trim and dashboard. Mounts in 6 places to the floor and rear wheel arches. MSA/FIA homologated.	
		RBF001 3SSU/A	Front cage, for single door bars	€ 240,80
		RBF001 3SSUD/A	Front cage, for single door bars, includes dash bar brackets	€ 252,00
		RBF001 3SSX/A	Front cage, for cross door bars	€ 257,60
		RBF001 3SSXD/A	Front cage, for cross door bars, includes dash bar brackets	€ 268,80
		RBF001 DB/A	Removable dash bar	€ 75,60
		RBF001 4SSU/A	Rear cage, no diagonal, for single door bars	€ 317,80
		RBF001 5SSU/A	Rear cage, single fixed diagonal, for single door bars	€ 334,60
		RBF001 5SXU/A	Rear cage, cross diagonal and harness bar, for single door bars and tunnel brackets	€ 405,00
		RBF001 5SRU/A	Rear cage, single removable diagonal, for single door bars	€ 393,40
		RBF001 5SXX/A	Rear cage, cross diagonal and harness bar, for cross door bars , and tunnel brace brackets	€ 417,20
		RBF001 TB/A	Rear cage tunnel brace	€ 102,20
		RBF001 DSUN/A	Single door bar nearside (left)	€ 68,60
		RBF001 DSUO/A	Single door bar offside (right)	€ 68,60
		RBF001 DXUN/A	Cross door bar nearside (left)	€ 135,80
RBF001 DXUO/A	Cross door bar offside (right)	€ 135,80		
				
More information				
FORD	Escort Mk1 	F107	CDS full weld-in cage with cross door bars, cross diagonal in backstays, single roof diagonal, lower backstays, front triangulation, harness bars, tunnel brace, rear strut brace. MSA/FIA homologated.	
		RBF107 6SSX	Full weld-in cage.	€ 799,90
More information				

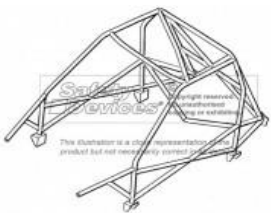
Make	Model	Part number	Description	Euro	
FORD	Escort Mk1	F108	T45 full weld-in cage with cross door bars, cross diagonal in backstays, single roof diagonal, lower backstays, front triangulation, harness bars, tunnel brace, rear strut brace. MSA/FIA homologated.		
		RBF108 6XSX	Full weld-in cage.	€ 1 113,00	
					
More information					
FORD	Escort Mk2	F 002-6P	6 point bolt-in cage. Clears normal trim and dashboard. Mounts in 6 places to the floor and rear wheel arches. MSA/FIA homologated. 37Kg.		
		<i>No dash bar brackets</i>	RBF002 3SSU/A	Front cage, for single door bars	€ 240,80
			RBF002 3SSUD/A	Front cage, for single door bars, includes dash bar brackets	€ 252,00
		<i>No dash bar brackets</i>	RBF002 3SSX/A	Front cage, for cross door bars	€ 257,60
			RBF002 3SSXD/A	Front cage, for cross door bars, includes dash bar brackets	€ 268,80
			RBF002 DB/A	Removable dash bar	€ 75,60
		<i>No tunnel brace brackets</i>	RBF002 4SSU/A	Rear cage, no diagonal, for single door bars	€ 317,80
		<i>No tunnel brace brackets</i>	RBF002 5SSU/A	Rear cage, single fixed diagonal, for single door bars	€ 334,60
			RBF002 5SXU/A	Rear cage, cross diagonal and harness bar, for single door bars and tunnel brace brackets	€ 405,00
		<i>No tunnel brace brackets</i>	RBF002 5SRU/A	Rear cage, single removable diagonal, for single door bars	€ 393,40
			RBF002 5SXX/A	Rear cage, cross diagonal and harness bar, for cross door bars and tunnel brace brackets	€ 417,20
			RBF002 TB/A	Rear cage tunnel brace	€ 102,20
			RBF002 DSUN/A	Single door bar nearside (left)	€ 68,60
			RBF002 DSUO/A	Single door bar offside (right)	€ 68,60
			RBF002 DXUN/A	Cross door bar nearside (left)	€ 135,80
	RBF002 DXUO/A	Cross door bar offside (right)	€ 135,80		
					
More information					

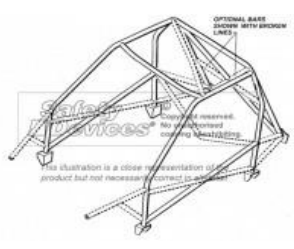
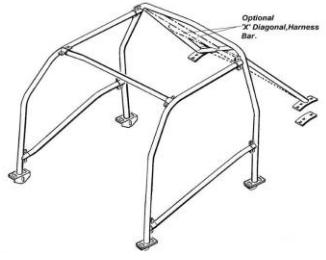
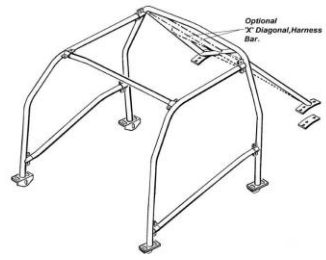
Make	Model	Part number	Description	Euro	
FORD	Escort Mk2	F 002-MP	Multi-point bolt-in cage. Front cage clears dashboard. Mounts in 12 places to the floor, A and B posts and rear wheel arches. MSA/FIA homologated. Turrent mount version will currently only fit cars with standard 13" wheel arches.		
		RBF002 3SMUD/A	Front cage, for single door bars, includes dash bar brackets	€ 271,60	
		RBF002 3SMXD/A	Front cage, for cross door bars, includes dash bar brackets	€ 282,80	
		RBF002 DB/A	Removable dash bar	€ 75,60	
		<i>Arch mount</i>	RBF002 5SMUA/A	Rear cage, single fixed diagonal, for single door bars, with tunnel brace brackets	€ 406,00
		<i>Arch mount</i>	RBF002 5SXXA/A	Rear cage, cross diagonal and harness bar, for cross door bars, and tunnel brace brackets	€ 532,00
		<i>Turret mount</i>	RBF002 5SMUT/A	Rear cage, single fixed diagonal, for single door bars, with tunnel brace brackets	€ 418,60
		<i>Turret mount</i>	RBF002 5SXXT/A	Rear cage, cross diagonal and harness bar, for cross door bars, and tunnel brace brackets	€ 520,80
			RBF002 TB/A	Rear cage tunnel brace	€ 102,20
			RBF002 DSUN/A	Single door bar nearside (left)	€ 68,60
			RBF002 DSUO/A	Single door bar offside (right)	€ 68,60
			RBF002 DXUN/A	Cross door bar nearside (left)	€ 135,80
			RBF002 DXUO/A	Cross door bar offside (right)	€ 135,80
			RBF002TMRF	Retro-fit kit: turret mounts only. Will currently only fit cars with standard 13" wheel arches.	€ 49,00
More information					
FORD	Escort Mk2	F 105	CDS full weld-in cage with cross door bars, cross diagonal in backstays, single roof diagonal, lower backstays, front triangulation, harness bars, tunnel brace. MSA/FIA homologated.		
		RBF105 6SXX	Full weld-in cage.	€ 918,25	
					
More information					

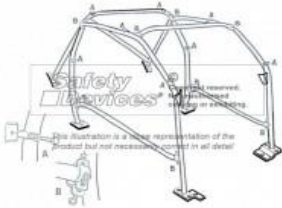
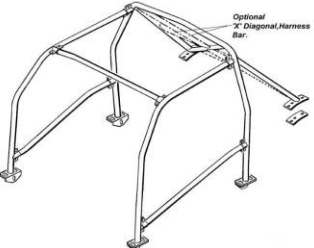
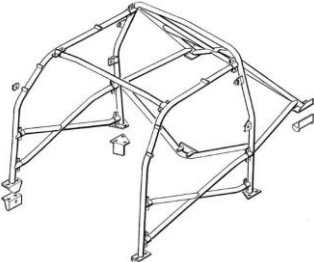
Make	Model	Part number	Description	Euro
FORD	Escort Mk2	F 106	T45 full weld-in cage with cross door bars, cross diagonal in backstays, single roof diagonal, lower backstays, front triangulation, harness bars, tunnel brace. MSA/FIA homologated.	
		RBF106 6XSU	Full weld-in cage.	€ 1 113,00
				
More information				
FORD	Escort Mk3 & Escort Mk4, with sunroof	F 018	6 point bolt-in cage. Clears normal trim and dashboard. Mounts in 6 places to the floor and rear wheel arches. MSA/FIA homologated.	
		RBF01 83SSS	Front cage	€ 248,07
		RBF01 85SSS	Rear cage, single fixed diagonal	€ 357,21
		RBF01 85SXS	Rear cage, scross diagonal and harness bar	€ 487,21
		RB000A1	Universal door bar (1 required per side)	€ 65,00
				
More information				
FORD	Escort Mk3 & Escort Mk4, no sunroof	F 000	6 Point bolt-in cage. Clears normal trim and dashboard. Mounts in 6 places to the floor and rear wheel arches. MSA/FIA homologated.	
		RBF000 3SSS	Front cage	€ 248,07
		RBF000 5SSS	Rear cage, single fixed diagonal	€ 357,21
		RBF000 5SXS	Rear cage, cross diagonal and harness bar	€ 487,21
		RB00A1	Universal door bar (1 required per side)	€ 65,00
				
More information				

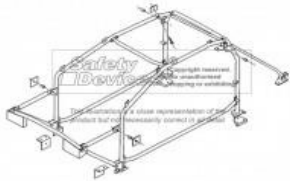
Make	Model	Part number	Description	Euro
FORD	Escort Mk3 & Escort Mk4, no sunroof 	F 019	Multi-point bolt-in cage. Penetrates dashboard. Cross diagonal, harness bars, single doorbars. MSA/FIA homologated.	
		RBF019 3SMU	Front cage, single door brackets.	€ 271,89
		RBF019 5SXU	Rear cage, cross diagonal and harness bars	€ 469,38
		RBF019 DSUN	Single door bar nearside (left)	€ 68,91
		RBF019 DSUO	Single door bar offside (right)	€ 68,91
More information				
FORD	Escort Mk5, with sunroof 	F062	6 point bolt-in cage. Clears normal trim and dashboard. Mounts to the floor and rear wheel arches. MSA/FIA homologated.	
		RBF062 3SSS	Front Cage	€ 254,00
		RBF062 5SSU	Rear cage, single fixed diagonal	€ 358,67
		RBF062 5SXU	Rear cage, cross diagonal	€ 442,67
		RBF062 DSUN	Door bar N/S (left)	€ 68,84
RBF062 DSUO	Door bar O/S (right)	€ 68,84		
More information				
FORD	Escort Mk5 & RS2000, no sunroof 	F091	Multi-point bolt-in roll cage. Clears normal trim and dashboard. Mounts to the floor and rear wheel arches. MSA/FIA homologated.	
		RBF091 3SMU	Front Cage	€ 254,00
		RBF091 FST	Front strut triangulation	€ 246,40
		RBF091 5SMU	Rear cage, single fixed diagonal	€ 392,00
		RBF091 5SXU	Rear cage, cross diagonal and harness bar	€ 525,00
		RBF091 RSB	Rear strut brace	€ 91,00
		RBF091 DSUN	Single door bar nearside (left)	€ 68,84
RBF091 DSUO	Single door bar offside (right)	€ 68,84		
More information				

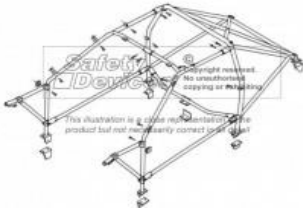
Make	Model	Part number	Description	Euro
FORD	Escort RS2000, with sunroof 	F 064	20 point multi-point bolt-in cage. Front cage penetrates dashboard and cage includes a dash bar. Rear cage has fixed diagonal and turret brace. Optional front triangulation. MSA/FIA homologated.	
		RBF064 FST	Front triangulation	€ 250,60
		RBF064 3SMU	Front cage	€ 299,84
		RBF064 5SMU	Rear cage, single fixed diagonal	€ 401,63
		RBF064 DSUN	Single door bar nearside (left)	€ 72,56
		RBF064 DSUO	Single door bar offside (right)	€ 72,56
More information				
FORD	Escort Cosworth 4x4 (1992) 	F 068	Bolt-in cage. Clears normal trim and dashboard. Mounts in 6 places to the floor and rear wheel arches. MSA/FIA homologated.	
		RBF068 3SSS	Front cage	€ 292,75
		RBF068 5SSS	Rear cage, single fixed diagonal	€ 345,07
		RBF068 5SXS	Rear cage, cross diagonal and harness bar	€ 475,07
		RB00A1	Universal door bar (1 required per side)	€ 65,00
More information				
FORD	Escort Cosworth 4x4 (1992) 	F 067	Multi point bolt-in cage. Front cage penetrates dashboard, rear cage has cross diagonal and tunnel brace. Mounts in 21 places to the floor and rear wheel arches. MSA/FIA homologated.	
		RBF067 FST	Front triangulation	€ 124,60
		RBF067 3SMU	Front cage	€ 334,60
		RBF067 5SMU	Rear cage, cross diagonal, turret brace, lower backstays and tunnel brace	€ 490,00
		RBF067 DSUN	Single door bar nearside (left)	€ 72,56
		RBF067 DSUO	Single door bar offside (right)	€ 72,56
More information				

Make	Model	Part number	Description	Euro
FORD	Escort Cosworth 4x4 (1992)	F 066	CDS weld-in cage. Available as full cage only. MSA/FIA homologated.	
		RBF066 6XXX	Full weld-in cage	€ 863,80

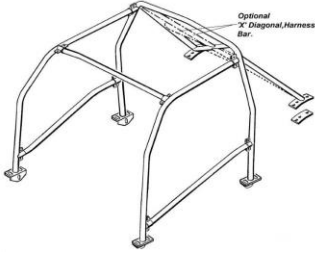
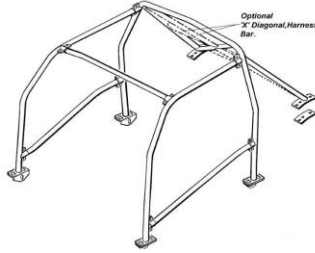
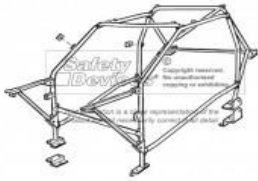
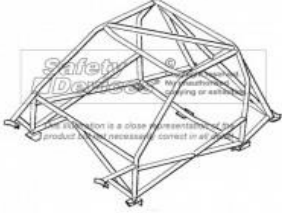

[More information](#)

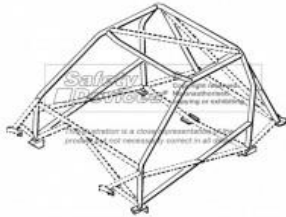
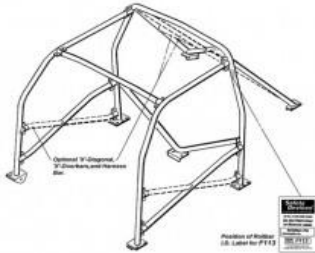
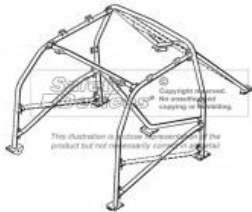
Make	Model	Part number	Description	Euro	
FORD	Fiesta Mk1 & Fiesta Mk2		F 005 Bolt-in cage. Clears normal trim and dashboard. Mounts in 6 places to the floor and rear wheel arches. MSA/FIA homologated.		
			RBF005 3SSS	Front cage	€ 248,07
			RBF005 5SSS	Rear cage, single fixed diagonal	€ 357,21
			RBF005 5SXS	Rear cage, cross diagonal and harness bar	€ 487,21
			RB00A1	Universal door bar (1 required per side)	€ 65,00
More information					
FORD	Fiesta Mk3 & Fiesta Mk4, no sunroof		F 044 Bolt-in cage. Clears normal trim and dashboard. Mounts in 6 places to the floor and rear wheel arches. Conforms to FIA Appendix J.		
			RBF044 3SSS	Front cage	€ 248,07
			RBF044 5SSS	Rear cage, single fixed diagonal	€ 357,21
			RBF044 5SXS	Rear cage, cross diagonal and harness bar	€ 487,21
			RB00A1	Universal door bar (1 required per side)	€ 65,00
More information					
FORD	Fiesta Mk3 & Fiesta Mk4		F 055 20 point multi-point bolt-in cage. Front cage penetrates dashboard and cage includes a dash bar. Rear cage has fixed diagonal and turret brace. Optional front triangulation. MSA/FIA homologated.		
			RBF055 FST	Front triangulation	€ 250,60
			RBF055 3SMU	Front cage	€ 299,84
			RBF055 5SMU	Rear cage, single fixed diagonal	€ 401,63
			RBF055 DSUN	Door bar N/S (left)	€ 72,56
			RBF055 DSUO	Door bar O/S (right)	€ 72,56
More information					
FORD	Fiesta Mk3 & Fiesta Mk4		F 081 CDS full weld-in cage with cross door bars, cross diagonal in backstays, single roof diagonal, lower backstays, front triangulation, rear strut brace, tunnel brace and dash bar. MSA/FIA homologated.		
			RBF081 6SXX	Full weld-in cage	€ 864,61
More information					

Make	Model	Part number	Description	Euro
FORD	Fiesta Mk3 & Fiesta Mk4	F 070	T45 full weld-in cage with cross door bars, cross diagonal in backstays, single roof diagonal, lower backstays, front triangulation, rear strut brace, tunnel brace and dash bar. MSA/FIA homologated.	
		RBF070 6XMU	Full weld-in cage	POA
				
More information				
FORD	Focus Mk1 (1998-2004), 3-door, with sunroof	F 113	6 point bolt-in cage. Clears normal trim and dashboard. Minor trim modifications required around backstays. Rear seat has to be folded flat. Includes tunnel brace as standard. MSA/FIA homologated.	
		RBF113 3SSU	Front cage, for single door bars	€ 235,49
		RBF113 3SSX	Front cage, for cross door bars	€ 250,66
		RBF113 5SSU	Rear cage, tunnel brace, single fixed diagonal, for single door bars	€ 353,16
		RBF113 5SSX	Rear cage, tunnel brace, single fixed diagonal, for cross door bars	€ 365,29
		RBF113 5SXX	Rear cage, tunnel brace, cross diagonal, harness bar, for cross door bars	€ 477,22
		RBF113 DSUN	Single door bar nearside (left)	€ 68,84
		RBF113 DSUO	Single door bar offside (right)	€ 68,84
		RBF113 DXUN	Cross door bar nearside (left)	€ 124,07
		RBF113 DXUO	Cross door bar offside (right)	€ 124,07
				
More information				
FORD	Focus Mk1 (1998-2004), 3-door, no sunroof	F 114	14 point bolt-in cage. Clears most trim and dashboard. Minor trim modifications required around backstays. Rear seat has to be folded flat. Includes tunnel brace and lower backstays as standard. Standard door cards cannot be used. MSA/FIA homologated.	
		RBF114 3SSU	Front cage, for single door bars	€ 271,89
		RBF114 3SSX	Front cage, for cross door bars	€ 287,06
		RBF114 5SSU	Rear cage, single fixed diagonal, for single door	€ 365,29
		RBF114 5SSX	Rear cage, single fixed diagonal, for cross door	€ 377,43
		RBF114 5SXX	Rear cage, cross diagonal, harness bar, for cross door bars	€ 511,28
		RBF114 DSUN	Single door bar nearside (left)	€ 68,84
		RBF114 DSUO	Single door bar offside (right)	€ 68,84
		RBF114 DXUN	Cross door bar nearside (left)	€ 124,07
		RBF114 DXUO	Cross door bar offside (right)	€ 124,07
				
More information				

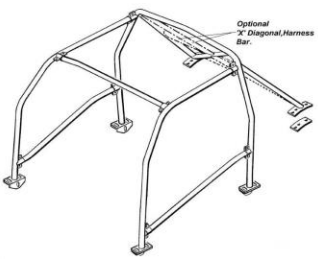
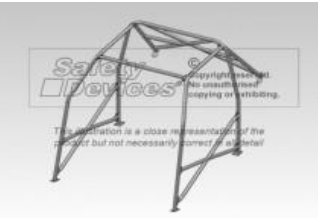
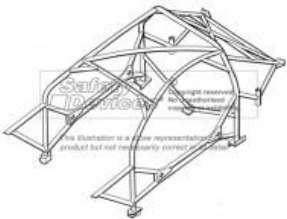
Make	Model	Part number	Description	Euro
FORD	Focus Mk1 (1998-2004), 3-door	F 111	CDS full weld-in cage with cross door bars, lower door bars, cross diagonal in backstays, cross roof diagonal, cross in main hoop, pit prop, lower backstays, front triangulation, harness bars, rear strut brace, A-pillar gussets. MSA/FIA homologated.	
		RBF111 6SSX	Full cage	€ 1 144,57
<p>More information</p>				
FORD	Focus Mk3 RS (2010-)	N/A	We do not offer a roll cage for this car yet. To express your interest in a roll cage for this car, please email motorsport@safetydevices.com	
<p>Not available</p>				
FORD	KA, 3-door hatchback	F102	13 point multi-point cage for single door bars. Clears the dash board. Mounted floor and wheel arches. MSA/FIA homologated.	
		RBF102 3SMU	Front cage	€ 329,00
		RBF102 5SMU	Rear cage, single fixed diagonal, lower back stays and tunnel brace	€ 392,00
		RBF102 DSUO	Single door bar nearside (left)	€ 71,40
		RBF102 DSUN	Single door bar offside (right)	€ 71,40
<p>More information</p>				

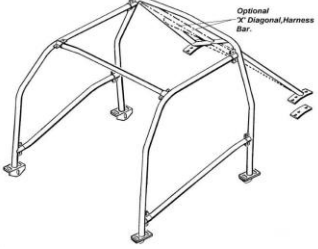
Make	Model	Part number	Description	Euro	
FORD	Mustang	F 013	6 point point bolt-in cage. Clears normal trim and dashboard. single diagonal, single door bars. MSA/FIA homologated.		
			RBF013 3SSU	Front cage	€ 271,89
		RBF013 5SSU	Rear cage, single fixed diagonal	€ 365,29	
		RBF013 5SRU	Rear cage, single removable diagonal	€ 449,29	
		RBF013 DSUN	Single door bar nearside (left)	€ 73,64	
		RBF013 DSUO	Single door bar offside (right)	€ 73,64	
More information					
FORD	Puma	F109	6 point cage. Clears the dash board. Mounted floor and wheel arches. MSA/FIA homologated.		
			RBF109 3SSU	Front cage, for single door bars	€ 235,49
		RBF109 3SSX	Front cage, for cross door bars.	€ 250,66	
		RBF109 5SSU	Rear cage, single fixed diagonal, for single door	€ 353,16	
		RBF109 5SXX	Rear cage, cross diagonal, harness bar, turret brace, for cross door bars.	€ 477,22	
		RBF109 DSUO	Single door bar nearside (left)	€ 68,84	
		RBF109 DSUN	Single door bar offside (right)	€ 68,84	
		RBF109 DXUN	Cross door bars nearside (left side)	€ 142,27	
RBF109 DXUO	Cross door bars offside (right side)	€ 142,27			
More information					
FORD	Puma	F103	CDS full weld-in cage with cross door bars, cross diagonal in backstays, single roof diagonal, lower backstays, front triangulation, harness bars, rear strut brace, tunnel brace, windscreen braces. MIA/FIA homologated.		
			RBF103 6SXX	Full weld-in cage.	€ 1 113,63
More information					

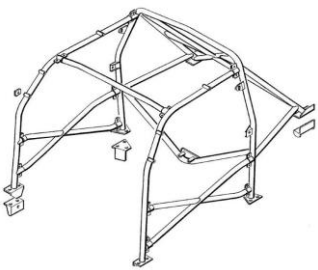
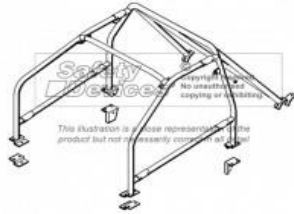
Make	Model	Part number	Description	Euro
FORD	Sapphire 4x4 Cosworth (sunroof) 4-door 	F 054	Bolt-in cage. Clears normal trim and dashboard. Mounts in 6 places to the floor and rear wheel arches. MSA/FIA homologated.	
		RBF05 43SSS	Front cage	€ 226,83
		RBF05 45SSS	Rear cage, single fixed diagonal	€ 345,07
		RBF05 45SXS	Rear cage, cross diagonal and harness bar	€ 475,07
		RB00A1	Universal door bar (1 required per side)	€ 65,00
More information				
FORD	Sapphire 4x4 2-door, no sunroof. Separate code for 4-door 	F 060	Bolt-in multi-point. Mounts to the shell in 19 points. Front cage penetrates dash. Rear cage with cross diagonals, turret mounted back-stays, lower back stays, rear strut and tunnel braces. MSA/FIA homologated.	
		RBF060 3XMU	Front cage, multi-point	€ 299,88
		RBF060 5XMU	Rear cage, cross diagonal, lower backstays, strut and tunnel brace	€ 494,56
		RBF060 DSUN	Single door bar nearside (left)	€ 63,53
		RBF060 DSUO	Single door bar offside (right)	€ 63,53
More information				
FORD	Sapphire 4x4 4-door, no sunroof. Separate code for 2-door 	F 147	Bolt-in multi-point. Mounts to the shell in 19 points. Front cage penetrates dash. Rear cage with cross diagonals, turret mounted back-stays, lower back stays, rear strut and tunnel braces. Not homologated.	
		RBF147 3XMU	Front cage, multi-point	€ 299,88
		RBF147 5XMU	Rear cage, cross diagonal, lower backstays, strut and tunnel brace	€ 494,56
		RBF147 DSUN	Single door bar nearside (left)	€ 63,53
		RBF147 DSUO	Single door bar offside (right)	€ 63,53
More information				
FORD	Sierra RS500 Cosworth 2-door, with sunroof and large rear wing 	F 080	6 point bolt-in cage. Clears normal trim and dashboard. Unique door bars with slipper tube joints. MSA/FIA homologated.	
		RBF080 3SSU	Front cage	€ 238,97
		RBF080 5SSU	Rear cage, single fixed diagonal	€ 334,28
		RBF080 5SXU	Rear cage, cross diagonal and harness bar	€ 464,28
		RBF080 DSUN	Single door bar nearside (left)	€ 60,52
		RBF080 DSUO	Single door bar offside (right)	€ 60,52
More information				

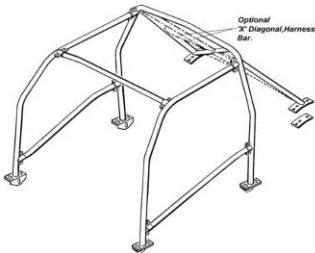
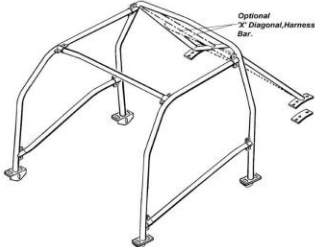
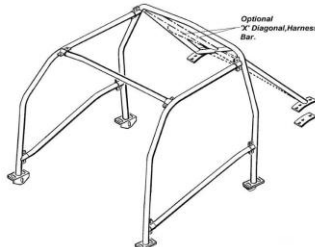
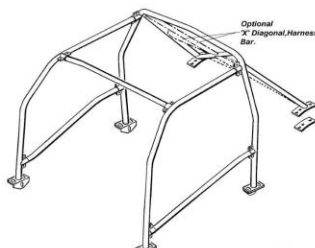
Make	Model	Part number	Description	Euro	
FORD	Sierra, 2-door, no sunroof		F 012 6 point bolt-in cage. Clears normal trim and dashboard. MSA/FIA homologated.		
			RBF012 3SSU	Front cage	€ 264,38
			RBF012 5SSU	Rear cage, single fixed diagonal	€ 369,33
			RBF012 5SXU	Rear cage, cross diagonal and harness bar	€ 499,33
More information					
FORD	Sierra, 4-door, with sunroof		F 022 Bolt-in cage. Clears normal trim and dashboard. Mounts in 6 places to the floor and rear wheel arches. MSA/FIA homologated.		
			RBF022 3SSS	Front cage	€ 248,07
			RBF022 5SSS	Rear cage, single fixed diagonal	€ 357,21
			RBF022 5SXS	Rear cage, cross diagonal and harness bar	€ 487,21
		RB00A1	Universal door bar (1 required per side)	€ 65,00	
More information					
FORD	Sierra, 4-door, no sunroof		F 033 Bolt-in cage. Clears normal trim and dashboard. Mounts in 6 places to the floor and rear wheel arches. MSA/FIA homologated.		
			RBF033 3SSS	Front cage	€ 248,07
			RBF033 5SSS	Rear cage, single fixed diagonal	€ 357,21
			RBF033 5SXS	Rear cage, cross diagonal and harness bar	€ 487,21
		RB00A1	Universal door bar (1 required per side)	€ 65,00	
More information					
FORD	Sierra Sapphire, 4-door, no sunroof		F 043 6 point bolt-in cage. Clears normal trim and dashboard. Mounts in 6 places to the floor and rear wheel arches. MSA/FIA homologated.		
			RBF043 3SSU	Front cage for single door bars	€ 249,20
			RBF043 5SSU	Rear cage, single fixed diagonal	€ 371,00
			RBF043 5SRU	Rear cage, single removable diagonal	€ 455,00
			RBF043 5SXU	Rear cage, cross diagonal and harness bars	€ 511,00
			RBF043 DSUN	Single door bar nearside (left)	€ 71,40
RBF043 DSUO	Single door bar offside (right)	€ 71,40			
More information					

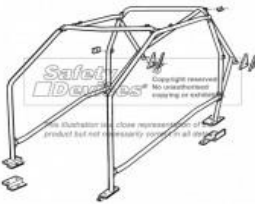
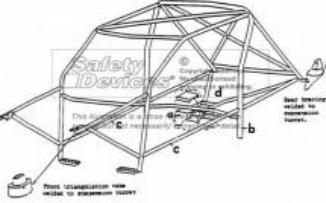
Make	Model	Part number	Description	Euro
FORD	Sierra 4+4 Cosworth, 2-door and 4-door, no sunroof 	F 036	Multi point bolt-in cage. MSA/FIA homologated.	
		RBF036 3SMU	Front cage, multi-point	€ 299,84
		RBF036 5SMU	Rear cage, multi-point with single fixed diagonal and lower backstays	€ 401,63
		RBF036 DSUN	Single door bar nearside (left)	€ 72,56
		RBF036 DSUO	Single door bar offside (right)	€ 72,56
More information				
FORD	Sierra Cosworth 4x4, no sunroof 	F097	CDS weld-in cage. Rear cage with cross diagonals, upper and lower backstays, rear strut brace, tunnel brace. Front cage with roof	
		RBF097 6SXU	Full weld-in cage.	€ 1 015,00
More information				