

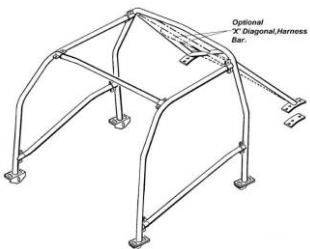
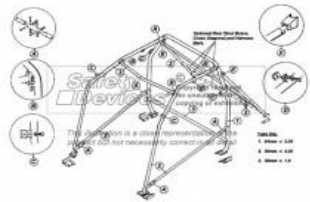

| Make   | Model                   | Part number  | Description   | Euro     |
|--|-------------------------|--------------|---|----------|
| PEUGEOT  | 106                     | <b>C 019</b> | 6 point bolt-in cage. Clears normal trim and dashboard. 45 mm main hoop. Rear cage with detachable back stays. MSA/FIA homologated. |          |
|  |                         | RBC019 3SSU  | Front cage  | € 220,33 |
|  |                         | RBC019 5SNU  | Rear cage, single fixed diagonal in removable backstays   | € 299,85 |
|  |                         | RBC019 5SXU  | Rear cage, cross diagonal and harness bar   | € 429,85 |
|  |                         | RBC019 DSUN  | Door bar nearside (left)  | € 64,25  |
|  |                         | RBC019 DSUO  | Door bar offside (right)  | € 64,25  |
|  <p>Optional X Diagonal/Harness Bar</p> <p><a href="#">More information</a></p> |                         |              |   |          |
| PEUGEOT  | 106, no sunroof         | <b>C 020</b> | 12 point bolt-in cage. Clears dashboard. 45mm main hoop. Rear cage with detachable back stays. MSA/FIA homologated.                 |          |
|  |                         | RBC020 3SMU  | Front cage  | € 263,23 |
|  |                         | RBC020 5SMU  | Rear cage, single fixed diagonal in removable backstays   | € 295,61 |
|  |                         | RBC020 5SXU  | Rear cage, cross diagonal, removable backstays, harness bar, tunnel brace, rear strut brace   | € 451,82 |
|  |                         | RBC020 DSUN  | Door bar nearside (left)  | € 64,25  |
|  |                         | RBC020 DSUO  | Door bar offside (right)  | € 64,25  |
|  <p><a href="#">More information</a></p>  |                         |              |   |          |
| PEUGEOT  | 106 (3-door and 5-door) | <b>C 046</b> | CDS weld-in cage. See separate sheet for full specification. MSA/FIA homologated. Available as full cage only.                      |          |
|  |                         | RBC046 6SXX  | Full weld in cage (all options)   | € 892,64 |
|  <p><a href="#">More information</a></p>                                      |                         |              |   |          |

| Make   | Model        | Part number   | Description   | Euro       |
|--|--------------|---------------|---|------------|
| PEUGEOT  | 106 (3-door) | <b>C 047</b>  | T45 full weld-in cage with cross door bars, cross diagonal in backstays, single roof diagonal, lower backstays, front triangulation, harness bars, rear strut brace, tunnel brace. MSA/FIA homologated.                         |            |
|  |              | RBC047 6SSU/F | T45 full weld-in cage   | <b>POA</b> |
|  <p style="font-size: small; text-align: center;">All Optional Parts<br/>require ROPS-Brake<br/>Must be a close reproduction of the<br/>part but not necessarily to scale in all detail</p> |              |               |   |            |
| <a href="#">More information</a>   |              |               |   |            |
| PEUGEOT  | 107 (3-door) | <b>C 052</b>  | 6 point bolt-in cage. All parts 45mm. Front cage has windscreen reinforcement bar. Options for roof cross, cross door bars, lower backstays and rear turret brace. N.B. Single door bars will not fit cross door bar positions. |            |
|  |              | RBC052 3SSU   | Front cage with windscreen reinforcement bar for single door bars, no roof cross.   | € 245,00   |
|  |              | RBC052 3SXU   | Front cage with windscreen reinforcement bar for single door bars and roof cross.   | € 287,00   |
|  |              | RBC052 3SXX   | Front cage with windscreen reinforcement bar for cross door bars and roof cross.  | € 315,00   |
|  |              | RBC052 5SSU   | Rear cage, single fixed diagonal for single door bars, no roof cross, no lower backstays.   | € 322,00   |
|  |              | RBC052 5XSU   | Rear cage, single fixed diagonal for single door bars and roof cross.   | € 343,00   |
|  |              | RBC052 5SXX   | Rear cage, cross diagonal, lower backstays, for roof cross and cross door bars.   | € 420,00   |
|  |              | RBC052 SB     | Rear strut brace/harness mount  | € 72,80    |
|  |              | RBC052 DSUN   | Single door bar nearside (left)   | € 68,60    |
|  |              | RBC052 DSUO   | Single door bar offside (right)   | € 68,60    |
|  |              | RBC052 DXUN   | Cross door bar nearside (left)  | € 127,40   |
|  |              | RBC052 DXUO   | Cross door bar offside (right)  | € 127,40   |
|   |              |               |   |            |
| <a href="#">More information</a>   |              |               |   |            |

| Make   | Model                              | Part number  | Description   | Euro     |
|--|------------------------------------|--------------|---|----------|
| PEUGEOT  | 205 and 205 1.6 GTI,<br>no sunroof | <b>C 012</b> | 6 point bolt-in cage. Clears normal trim and dashboard. 45 mm main hoop. MSA/FIA homologated.   |          |
|  |                                    | RBC012 3SSU  | Front cage  | € 222,19 |
|  |                                    | RBC012 5SSU  | Rear cage, single fixed diagonal  | € 329,36 |
|  |                                    | RBC012 5SXU  | Rear cage, cross diagonal and harness bar   | € 459,36 |
|  |                                    | RBC012 DSUN  | Door bar nearside (left)  | € 66,11  |
|  |                                    | RBC012 DSUO  | Door bar offside (right)  | € 66,11  |
|   |                                    |              |   |          |
| <a href="#">More information</a>   |                                    |              |   |          |
| PEUGEOT  | 205 and 205 1.6 GTI,<br>no sunroof | <b>C 044</b> | CDS 12 point multi point bolt-in cage built for 2002 Challenge. Derived from C042. No front triangulation. Single door bars only. Rear cage has cross diagonal and harness bar. Front legs through dash. MSA/FIA homologated. |          |
|  |                                    | RBC044 3SMU  | Front cage  | € 229,11 |
|  |                                    | RBC044 5SXU  | Rear cage, cross diagonal and harness bar   | € 377,58 |
|  |                                    | RBC044 DSUN  | Single door bar nearside (left)   | € 66,11  |
|  |                                    | RBC044 DSUO  | Single door bar offside (right)   | € 66,11  |
|  |                                    |              |   |          |
| <a href="#">More information</a>   |                                    |              |   |          |

| Make                             | Model                              | Part number  | Description   | Euro     |
|----------------------------------|------------------------------------|--------------|---|----------|
| PEUGEOT                          | 205 and 205 1.6 GTI,<br>no sunroof | <b>C 042</b> | Advanced 17 point multi-point bolt-in cage. Optional front triangulation, front turret brace, tunnel brace and cross door bars. MSA/FIA homologated.  |          |
|                                  |                                    | RBC042 3SSX  | Front cage  | € 268,86 |
|                                  |                                    | RBC042 5SXX  | Rear cage, cross diagonal, harness bars, lower backstays.   | € 399,38 |
|                                  |                                    | RBC042 DXUN  | Cross door bar nearside (left)  | € 134,48 |
|                                  |                                    | RBC042 DXUO  | Cross door bar offside (right)  | € 134,48 |
|                                  |                                    | RBC042 FST   | Front triangulation   | € 213,50 |
|                                  |                                    | RBC042 TB    | Tunnel brace  | € 82,31  |
| <a href="#">More information</a> |                                    |              |   |          |
| PEUGEOT                          | 205 and 205 1.6 GTI,<br>no sunroof | <b>C 043</b> | CDS full weld-in roll cage with cross door bars. Front has triangulation and single roof diagonal. Rear has tunnel brace and cross diagonals with harness bar in backstays. MSA/FIA homologated. Available as full cage only. |          |
|                                  |                                    | RBC043 6SXX  | Full weld in cage (all options)   | € 847,27 |
| <a href="#">More information</a> |                                    |              |   |          |

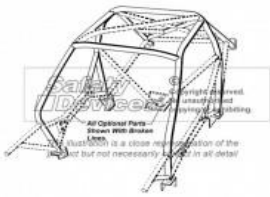
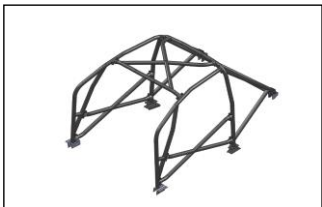
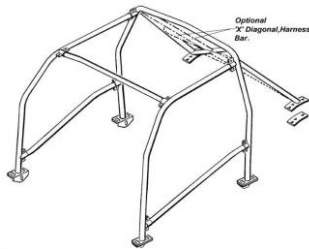
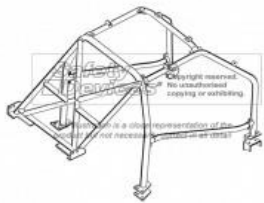
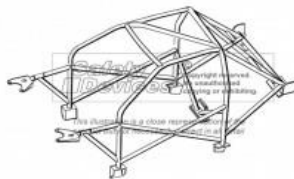
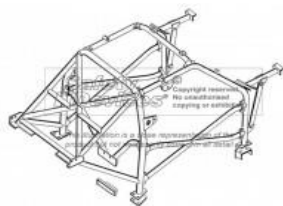

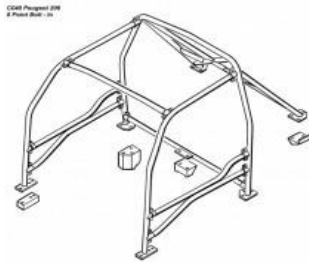
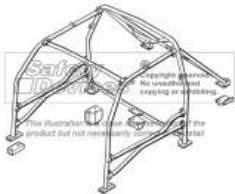
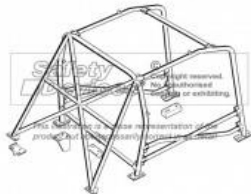
| Make  | Model                       | Part number  | Description   | Euro     |
|---|-----------------------------|--------------|---|----------|
| PEUGEOT   | 206 (3-door),<br>no sunroof | <b>C 040</b> | 6 point bolt-in cage. Clears trim and dashboard. Single or cross door bars. Optional tunnel brace and front strut brace. MSA/FIA homologated.                     |          |
|   |                             | RBC040 3SSU  | Front cage for single door bars   | € 218,47 |
|   |                             | RBC040 3SSX  | Front cage for cross door bars  | € 230,59 |
|   |                             | RBC040 5SSU  | Rear cage, single diagonal for single door bars   | € 321,50 |
|   |                             | RBC040 5SXX  | Rear cage, cross diagonal, harness bar, for cross door bars   | € 447,38 |
|   |                             | RBC040 TB    | Tunnel brace  | € 89,31  |
|   |                             | RBC040 FSB   | Front strut brace (bolt-on)   | € 119,78 |
|   |                             | RBC040 DSUN  | Single door bar nearside (left)   | € 62,38  |
|   |                             | RBC040 DSUO  | Single door bar offside (right)   | € 62,38  |
|   |                             | RBC040 DXUN  | Cross door bar nearside (left)  | € 135,00 |
|   |                             | RBC040 DXUO  | Cross door bar offside (right)  | € 135,00 |
|    |                             |              |   |          |
| <a href="#">More information</a>  |                             |              |   |          |
| PEUGEOT   | 206 (3-door),<br>no sunroof | <b>C 041</b> | 10 point multi-point bolt-in cage. Clears normal trim and dashboard. Single or cross door bars. Optional front strut brace and tunnel brace. MSA/FIA homologated. |          |
|   |                             | RBC041 3SSU  | Front cage for single door bars   | € 242,73 |
|   |                             | RBC041 3SSX  | Front cage for cross door bars  | € 254,87 |
|   |                             | RBC041 5SSU  | Rear cage, single diagonal, single door bar mounts  | € 321,50 |
|   |                             | RBC041 5SXX  | Rear cage, cross diagonal, harness bar, cross door bar mounts   | € 447,38 |
|   |                             | RBC041 TB    | Tunnel Brace  | € 89,31  |
|   |                             | RBC041 FSB   | Front strut brace (bolt-on)   | € 119,78 |
|   |                             | RBC041 DSUN  | Single door bar nearside (left)   | € 62,38  |
|   |                             | RBC041 DSUO  | Single door bar offside (right)   | € 62,38  |
|   |                             | RBC041 DXUN  | Cross door bar nearside (left)  | € 135,00 |
|   |                             | RBC041 DXUO  | Cross door bar offside (right)  | € 135,00 |
|  |                             |              |   |          |
| <a href="#">More information</a>  |                             |              |   |          |
| PEUGEOT   | 206, 3-door                 | <b>C 050</b> | 10 point bolt-in. Single or cross door bars. Optional front strut brace and tunnel brace. Complies with FIA Appendix J.   |          |
|   |                             | RBC050 3SMU  | Front cage for single door bars   | € 248,32 |
|   |                             | RBC050 3SSX  | Front cage for cross door bars  | € 260,46 |
|   |                             | RBC050 5SMU  | Rear cage, single diagonal, single door bar mounts  | € 336,14 |
|   |                             | RBC050 5SXX  | Rear cage, cross diagonal, harness bar, cross door bar mounts   | € 441,52 |
|   |                             | RBC050 TB    | Tunnel brace  | € 89,31  |
|   |                             | RBC041 FSB   | Front strut brace (bolt-on)   | € 119,78 |
|   |                             | RBC050 DSUN  | Single door bar nearside (left)   | € 64,25  |
|   |                             | RBC050 DSUO  | Single door bar offside (right)   | € 64,25  |
|   |                             | RBC050 DXUN  | Cross door bar nearside (left)  | € 123,83 |
|   |                             | RBC050 DXUO  | Cross door bar offside (right)  | € 123,83 |
|  |                             |              |   |          |
| <a href="#">More information</a>  |                             |              |   |          |

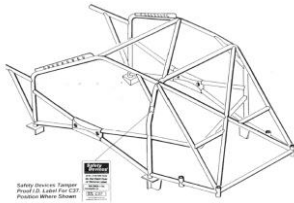
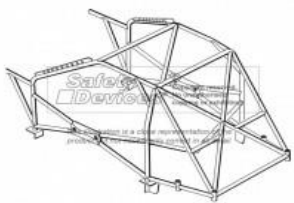
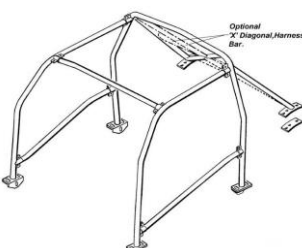
| Make   | Model       | Part number  | Description   | Euro     |
|--|-------------|--------------|---|----------|
| PEUGEOT  | 206         | <b>C 037</b> | CDS full weld-in cage with cross door bars, cross diagonal in backstays, single roof diagonal, lower backstays, front triangulation, harness bars, rear strut brace, tunnel brace, A-pillar gussets. MSA/FIA homologated. |          |
|  |             | RBC037 6SSU  | CDS full weld-in cage   | € 945,00 |
|  <p>Safety Devices Partner<br/>Please Call Us For More Information<br/>Position Where Shown</p> <p><a href="#">More information</a></p> |             |              |   |          |
| PEUGEOT  | 206         | <b>C 038</b> | T-45 weld-in cage. See separate sheet for full specification. MSA/FIA homologated. Available as full cage only.   |          |
|  |             | RBC038 6XSU  | Full weld in cage (all options)   | POA      |
|  <p><a href="#">More information</a></p>  |             |              |   |          |
| PEUGEOT  | 306, 3-door | <b>C 025</b> | 6 point bolt-in. Clears normal trim and dashboard. MSA/FIA homologated.   |          |
|  |             | RBC025 3SSU  | Front cage  | € 238,97 |
|  |             | RBC025 5SSU  | Rear cage, single fixed diagonal  | € 371,03 |
|  |             | RBC025 5SXU  | Rear cage, cross diagonal and harness bar   | € 501,03 |
|  |             | RBC025 DSUN  | Door bar nearside (left)  | € 71,43  |
|  |             | RBC025 DSUO  | Door bar offside (right)  | € 71,43  |
|  <p>Optional<br/>"X" Diagonal/Harness<br/>Bar.</p> <p><a href="#">More information</a></p>  |             |              |   |          |

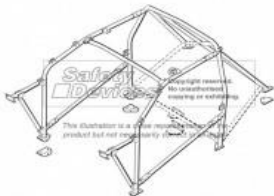
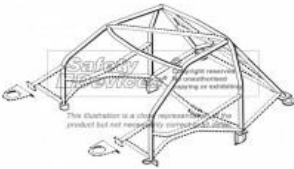
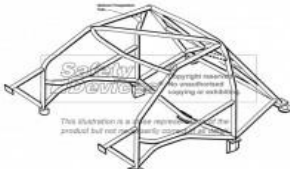
| Make  | Model       | Part number  | Description   | Euro     |
|---|-------------|--------------|---|----------|
| PEUGEOT   | 306, 3-door | <b>C 026</b> | 17 point multi-point bolt-in. Front cage penetrates dashboard. Rear available with single or cross diagonal. Optional tunnel brace. MSA/FIA homologated.  |          |
|   |             | RBC026 3SMU  | Front cage  | € 253,90 |
|   |             | RBC026 5SMU  | Rear cage, single fixed diagonal  | € 394,87 |
|   |             | RBC026 5SXU  | Rear cage, cross diagonal and lower back stays  | € 497,34 |
|   |             | RBC026 FST   | Front triangulation   | € 198,97 |
|   |             | RBC026 TB    | Tunnel brace  | € 83,26  |
|   |             | RBC026 DSUN  | Door bar nearside (left)  | € 71,43  |
|   |             | RBC026 DSUO  | Door bar offside (right)  | € 71,43  |
|  <p>This illustration is a clear representation of the product but not necessarily a photograph.</p>   |             |              |   |          |
| <a href="#">More information</a>  |             |              |   |          |
| PEUGEOT   | 306         | <b>C 030</b> | CDS weld-in cage. See separate sheet for full specification. MSA/FIA homologated. Available as full cage only.  |          |
|   |             | RBC030 6SSU  | Full weld in cage (all options)   | € 789,67 |
|  <p>This illustration is a clear representation of the product but not necessarily a photograph.</p>   |             |              |   |          |
| <a href="#">More information</a>  |             |              |   |          |
| PEUGEOT   | 306         | <b>C 029</b> | T45 full weld-in cage with cross door bars, cross diagonal in backstays, single roof diagonal, lower backstays, front triangulation, harness bars, rear strut brace, tunnel brace. MSA/FIA homologated. |          |
|   |             | RBC029 6XSU  | T45 full weld-in cage   | POA      |
|  <p>This illustration is a clear representation of the product but not necessarily a photograph.</p> |             |              |   |          |
| <a href="#">More information</a>  |             |              |   |          |

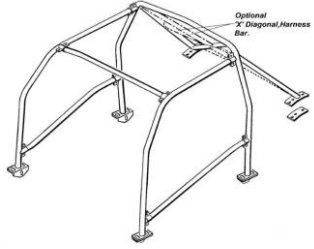
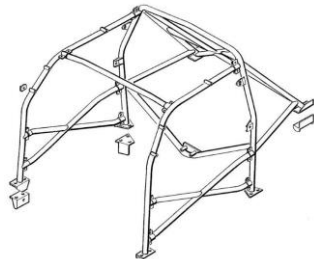
| Make  | Model | Part number  | Description  | Euro     |
|---|-------|--------------|--|----------|
| PEUGEOT   | 309   | <b>C 016</b> | 6 point bolt-in cage. Front cage clears dashboard. Rear cage available with removable diagonal only. This cage is not homologated.   |          |
|   |       | RBC016 3SSS  | Front cage   | € 212,83 |
|   |       | RBC016 5SRS  | Rear cage, single removable diagonal   | € 388,88 |
|   |       | RB00A1       | Universal door bar (1 required per side)   | € 65,00  |
|  |       |              |  |          |
| <a href="#">More information</a>  |       |              |  |          |
| PEUGEOT   | 309   | <b>C 014</b> | 14 point bolt-in cage. Rear with fixed diagonal only and mounts to sills/ rear floor pan. Front cage mounts to sills, cant rails and screen pillars. Single unique door bars. MSA/FIA homologated. |          |
|   |       | RBC014 3SMU  | Front cage   | € 251,36 |
|   |       | RBC014 5SMU  | Rear cage, single fixed diagonal   | € 281,81 |
|   |       | RBC014 5SXU  | Rear cage, cross diagonal and harness bar  | € 411,81 |
|   |       | RBC014 DSUN  | Single door bar nearside (left)  | € 63,53  |
|   |       | RBC014 DSUO  | Single door bar offside (right)  | € 63,53  |
|  |       |              |  |          |
| <a href="#">More information</a>  |       |              |  |          |