

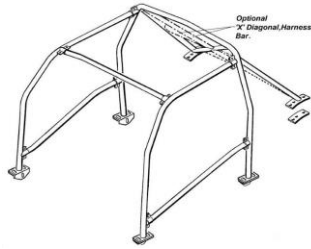

Make	Model	Part number	Description	Euro	
VAUXHALL OPEL	Ascona A		O 002 6 point bolt-in cage for universal door bars. Clears normal trim and dashboard. Front cage mounts to floor and rear cage mounts to floor and rear wheel arches. MSA/FIA homologated.		
			RBO002 3SSS	Front cage	€ 240,80
			RBO002 5SSS	Rear cage, single fixed diagonal	€ 385,00
			RBO002 5SXS	Rear cage, cross diagonal	€ 427,00
			TBC - specify harness bar when ordering	Rear cage, cross diagonal and harness bar	€ 525,00
			RB00A1	Universal door bar (1 required per side)	€ 65,00
More information					
VAUXHALL OPEL	Manta A, 2-door Coupe		O 003 6 point bolt-in cage for universal door bars. Clears normal trim and dashboard. Front cage mounts to floor and rear cage mounts to floor and rear wheel arches. MSA/FIA homologated.		
			RBO003 3SSS	Front cage	€ 240,80
			RBO003 5SSS	Rear cage, single fixed diagonal	€ 385,00
			RBO003 5SRS	Rear cage, single removable diagonal	€ 427,00
			RBO003 5SXS	Rear cage, cross diagonal	€ 427,00
			TBC - specify harness bar when ordering	Rear cage, cross diagonal and harness bar	€ 525,00
RB00A1	Universal door bar (1 required per side)	€ 65,00			
More information					
VAUXHALL OPEL	Ascona B and Cavalier Mk1		O 007 6 point bolt-in cage. Clears normal trim and dashboard. Front cage mounts to floor and rear cage mounts to floor and rear wheel arches. MSA/FIA homologated.		
			RBO007 3SSS	Front cage	€ 240,80
			RBO007 5SSS	Rear cage, single fixed diagonal	€ 363,27
			RBO007 5SXS	Rear cage, cross diagonal and harness bar	€ 493,27
			RB00A1	Universal door bar (1 required per side)	€ 65,00
More information					

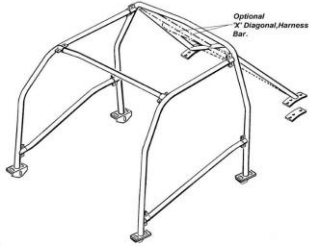

Make	Model	Part number	Description	Euro	
VAUXHALL OPEL	Astra Mk1 and Kadett D		O 013 6 point bolt-in cage. Clears all normal trim and dashboard. Front cage mounts to floor and rear cage mounts to floor and wheel arches. Single unique door bars. MSA/FIA homologated.		
			RBO013 3SSU	Front cage	€ 240,80
			RBO013 5SSU	Rear cage, single fixed diagonal	€ 363,27
			RBO013 5SXU	Rear cage, cross diagonal and harness bar	€ 493,27
			RBO013 DSUN	Single door bar N/S (left)	€ 70,31
			RBO013 DSUO	Single door bar O/S (right)	€ 70,31
More information					
VAUXHALL OPEL	Astra Mk2 and Kadett E		O 018 6 point bolt-in cage. Clears normal trim and dashboard. Front cage mounts to floor and rear cage mounts to floor and rear wheel arches. Single unique door bars. MSA/FIA homologated.		
			RBO018 3SSU	Front cage	€ 248,32
			RBO018 5SSU	Rear cage, single fixed diagonal	€ 342,19
			RBO018 5SXU	Rear cage, cross diagonal and harness bar	€ 472,19
			RBO018 DSUN	Single door bar N/S (left)	€ 66,98
			RBO018 DSUO	Single door bar O/S (right)	€ 66,98
More information					
VAUXHALL OPEL	Astra Mk3		O 034 CDS weld-in cage, cross diagonal, lower backstays, turret brace, tunnel brace, single roof diagonal, cross door bars, triangulation. MSA/FIA homologated.		
			RBO034 6SXX	Full weld-in cage to FIA Specification.	€ 910,00
More information					

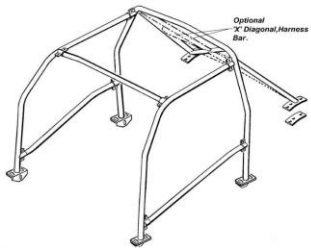
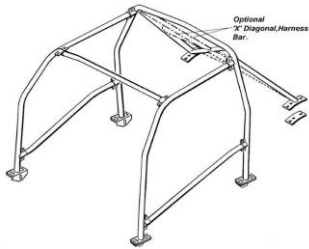
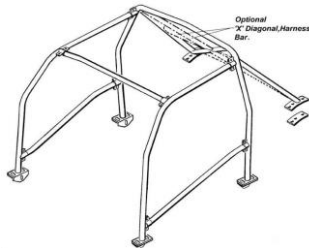
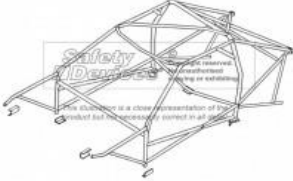
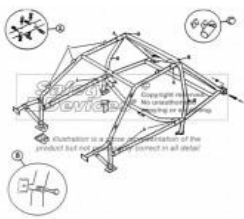
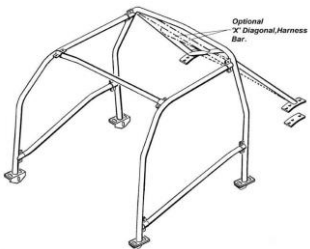

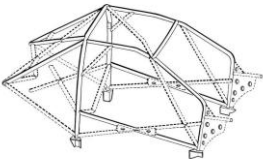
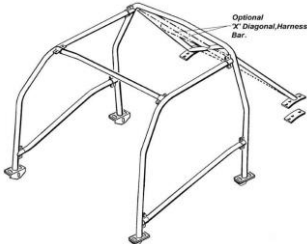
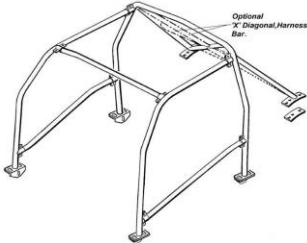
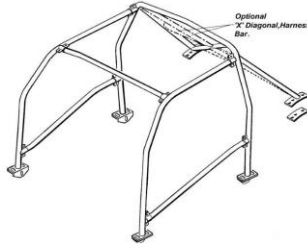
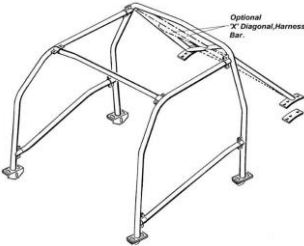
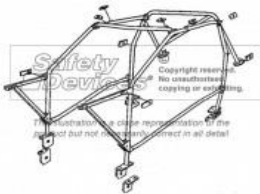
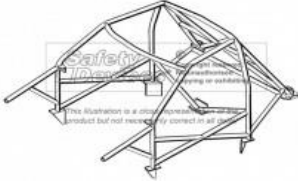
Make	Model	Part number	Description	Euro
VAUXHALL OPEL	Astra Mk3 	O 035	17-point bolt-in cage. Front cage penetrated dashboard but clears most trim. Single unique door bars. MSA/FIA homologated.	
		RBO035 3SMU	Front cage	€ 277,20
		RBO035 FST	Front triangulation	€ 168,00
		RBO035 5SXU	Rear cage, cross diagonal, harness bar, lower backstays, tunnel brace	€ 478,80
		RBO035 DSUN	Single door bar N/S (left)	€ 68,60
		RBO035 DSUO	Single door bar O/S (right)	€ 68,60
More information				
VAUXHALL OPEL	Astra Mk4, no sunroof 	O 056	6 point bolt-in cage. Clears normal trim and dashboard. Front cage mounts to floor and rear cage mounts to floor and rear wheel arches. Single or cross door bars.	
		RBO0563 SSU	Front cage	€ 254,00
		RBO0565 SSU	Rear cage, single fixed diagonal	€ 358,67
		RBO0565 SXU	Rear cage, cross diagonal, harness bar	€ 498,67
		RBO056 DSUN	Single door bar N/S (left)	€ 68,91
		RBO056 DSUO	Single door bar O/S (right)	€ 68,91
		RBO056 DXUN	Cross door bar N/S (left)	€ 135,80
RBO056 DXUO	Cross door bar O/S (right)	€ 135,80		
More information				
VAUXHALL OPEL	Astra Mk5 'H' VXR Sport Hatchback 	O 065	4 point bolt-in rear track day cage. Mounts to floor and rear wheel arches. Not homologated.	
		RBO065 5SSS	Rear cage, single fixed diagonal and harness bar	€ 436,80
		RBO065 5SXS	Rear cage, cross diagonal, harness bar	€ 520,80
More information				

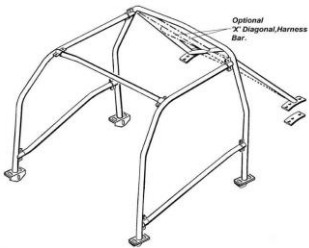
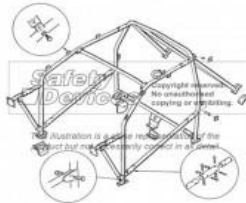
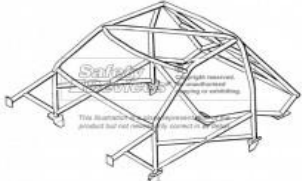
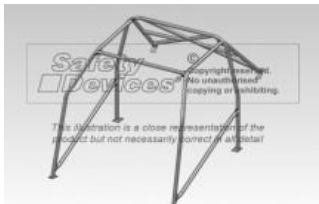
Make	Model	Part number	Description	Euro
VAUXHALL OPEL	Cavalier (1991-1995)	O 038	CDS full weld-in cage, front triangulation, cross diagonal, harness bar, lower backstays, rear turret brace and tunnel brace. This cage does not have profile ends. All tubes are straight cut. Available as full cage only.	
		RBO038 6SXX	Full weld-in cage.	€ 903,00
				
More information				
VAUXHALL OPEL	Chevette and Kadett C saloon	O 001	6-point bolt-in cage to clear normal trim and dashboard. Front cage mounts to floor. Rear cage mounts to floor and rear wheel arches. Universal door bars. MSA/FIA homologated.	
		RBO001 3SSS	Front cage	€ 233,80
		RBO001 4SSS	Rear cage, no diagonal	€ 322,49
		RBO001 5SSS	Rear cage, single fixed diagonal	€ 365,89
		RBO001 5SRS	Rear cage, single removable diagonal	€ 382,41
		RBO002 6SXS	Rear cage, cross diagonal and harness bar	€ 495,89
				
More information				
VAUXHALL OPEL	Chevette Hatchback, Chevette 1256, Chevette HS and Kadett C Hatchback	O 006	6-point bolt-in cage to clear normal trim and dashboard. Front cage mounts to floor. Rear cage mounts to floor and rear wheel arches. Universal door bars. MSA/FIA homologated.	
		RBO006 3SSS	Front cage	€ 233,80
		RBO006 4SSS	Rear cage, no diagonal	€ 322,49
		RBO006 5SSS	Rear cage, single fixed diagonal	€ 365,89
		RBO006 5SRS	Rear cage, single removable diagonal	€ 449,89
		RBO006 5SXS	Rear cage, cross diagonal and harness bar	€ 495,89
		RB00A1	Universal door bar (1 required per side)	€ 65,00
				
More information				
VAUXHALL OPEL	Chevette, Kadett C GT/E Coupe, Kadett C 1600 Rallye RWD Coupe	O 004	6-point bolt-in cage to clear normal trim and dashboard. Front cage mounts to floor. Rear cage mounts to floor and rear wheel arches. Universal door bars. MSA/FIA homologated.	
		RBO004 3SSS	Front Cage	€ 233,80
		RBO004 4SSS	Rear cage, no diagonal	€ 329,49
		RBO004 5SSS	Rear cage, single fixed diagonal	€ 372,89
		RBO004 5SRS	Rear cage, single removable diagonal	€ 456,89
		RBO004 5SXS	Rear cage, cross diagonal and harness bar	€ 502,89
		RB00A1	Universal door bar (1 required per side)	€ 65,00
				
More information				

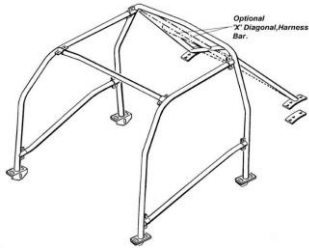
Make	Model	Part number	Description	Euro
VAUXHALL OPEL	Corsa A and Nova (1983-1993), no sunroof	O 014	6 point bolt-in cage. Clears normal trim and dashboard. Front cage mounts to floor and rear cage mounts to floor and rear wheel arches. Single unique door bars. MSA/FIA homologated.	
		RBO014 3SSU	Front cage	€ 238,00
		RBO014 5SSU	Rear cage, single fixed diagonal	€ 341,05
		RBO014 5SXU	Rear cage, cross diagonal and harness bar	€ 471,05
		RBO014 DSUN	Single door bar N/S (left)	€ 66,98
		RBO014 DSUO	Single door bar O/S (right)	€ 66,98
	More information			
VAUXHALL OPEL	Corsa A and Nova (1983-1993), no sunroof	O 022	16 point bolt-in. Clears most trim. Front cage penetrates dashboard. Rear cage with single fixed diagonal. Optional front triangulation. Single unique door bars. MSA/FIA homologated.	
		RBO022 3SMU	Front cage	€ 299,63
		RBO022 5SMU	Rear cage, single fixed diagonal	€ 393,61
		RBO022 5SXU	Rear cage, cross diagonal and harness bar	€ 523,61
		RBO022 FST	Front triangulation	€ 218,58
		RBO022 DSUN	Single door bar N/S (left)	€ 64,25
		RBO022 DSUO	Single door bar O/S (right)	€ 64,25
	More information			
VAUXHALL OPEL	Corsa A and Nova (1983-1993), 3-door hatchback, no sunroof	O 032	CDS weld-in cage, cross door bars, front triangulation, cross diagonal, harness bar, lower backstays, rear turret brace and tunnel brace. MSA/FIA homologated.	
		RBO032 6SXX	Full CDS weld-in cage.	€ 903,00
		More information		

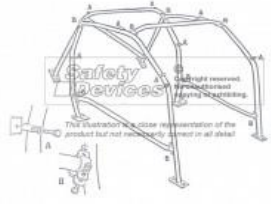
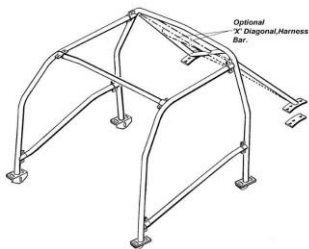
Make	Model	Part number	Description	Euro	
VAUXHALL OPEL	Corsa B (1993-2000)	O 040	6 point bolt-in cage. Clears normal trim and dashboard. Front cage mounts to floor and rear cage mounts to floor and rear wheel arches. Single unique door bars. MSA/FIA homologated.	€ 437,12	
			RBO040 3SSU	Front cage	€ 260,19
		RBO040 5SSU	Rear cage, single fixed diagonal	€ 342,19	
		RBO040 5SXU	Rear cage, cross diagonal and harness bar	€ 472,19	
		RBO040 DSUN	Single door bar N/S (left)	€ 66,98	
		RBO040 DSUO	Single door bar O/S (right)	€ 66,98	
More information					
VAUXHALL OPEL	Corsa B (1993-2000)	O 041	19 point bolt-in. Clears most trim. Front cage penetrates dashboard. Rear cage with single fixed diagonal and tunnel brace. Optional front triangulation. Single unique door bars with slipper joints. MSA/FIA homologated.		
			RBO0413SMU	Front cage	€ 311,77
		RBO0415SMU	Rear cage, single fixed diagonal, tunnel brace	€ 390,78	
		RBO0415SXU	Rear cage, cross diagonal and harness bar	€ 520,78	
		RBO041FST	Front triangulation	€ 184,30	
		RBO041DSUN	Single door bar N/S (left)	€ 62,38	
RBO041DSUO	Single door bar O/S (right)	€ 62,38			
More information					
VAUXHALL OPEL	Corsa B (1993-2000)	O 050	Full CDS weld-in cage, part profiled ends, cross door bars, tunnel brace, front triangulation, rear chassis brace, rear strut brace, dashbar, roof diagonal, cross diagonal and harness bar.		
			RBO050 6SXX	Full CDS weld-in cage.	€ 875,50
More information					
VAUXHALL OPEL	Corsa C (2000) 2-door and 4-door, with sunroof	O 059	6 point bolt-in cage. Clears normal trim and dashboard. Front cage mounts to floor and rear cage mounts to floor and rear wheel arches. Single unique door bars. MSA/FIA homologated.		
			RBO059 3SSU	Front cage	€ 295,90
		RBO059 5SSU	Rear cage, single fixed diagonal	€ 372,86	
		RBO059 5SXU	Rear cage, cross diagonal, harness bar	€ 481,92	
		RBO059 DSUN	Single door bar N/S (left)	€ 77,06	
		RBO059 DSUO	Single door bar O/S (right)	€ 77,06	
More information					

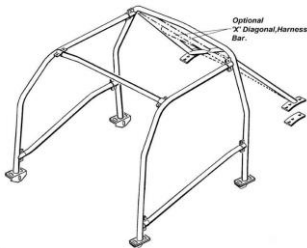
Make	Model	Part number	Description	Euro
VAUXHALL OPEL	Magnum and Fireza 	O 008	6 point bolt-in cage. Clears normal trim and dashboard. Front cage mounts to floor and rear cage mounts to floor and rear wheel arches. MSA/FIA homologated.	
		RBO008 3SSS	Front cage	€ 238,97
		RBO008 5SSS	Rear cage, single fixed diagonal	€ 338,31
		RBO008 5SXS	Rear cage, cross diagonal and harness bar	€ 468,31
		RB00A1	Universal door bar (1 required per side)	€ 65,00
More information				
VAUXHALL OPEL	Manta B 2-door Coupe 	O 005	6 point bolt-in cage. Clears normal trim and dashboard. Front cage mounts to floor and rear cage mounts to floor and rear wheel arches. MSA/FIA homologated.	
		RBO005 3SSU	Front cage	€ 235,20
		RBO005 5SSU	Rear cage, single fixed diagonal	€ 362,60
		RBO005 5SRU	Rear cage, single removable diagonal	€ 446,60
		RBO005 5SXU	Rear cage, cross diagonal, harness bars	€ 497,00
		RBO005 DSUN	Single door bar N/S (left)	€ 70,31
RBO005 DSUO	Single door bar O/S (right)	€ 70,31		
More information				
VAUXHALL OPEL	Manta B 2-door Coupe 	O 015	12-point bolt-in cage. Front cage penetrated dashboard but clears most trim. Single unique door bars. MSA/FIA homologated.	
		RBO015 3SMU	Front cage, multi-point	€ 254,13
		RBO015 5SMU	Rear cage, single fixed diagonal	€ 371,00
		RBO015 5SXU	Rear cage, cross diagonal, harness bars	€ 504,00
		RBO015 DSUN	Single door bar N/S (left)	€ 70,31
RBO015 DSUO	Single door bar O/S (right)	€ 70,31		
More information				
VAUXHALL OPEL	Viva HC 	O 009	6 point bolt-in cage. Clears normal trim and dashboard. Front cage mounts to floor and rear cage mounts to floor and rear wheel arches. MSA/FIA homologated.	
		RBO009 3SSS	Front cage	€ 238,97
		RBO009 5SSS	Rear cage, single fixed diagonal	€ 366,31
		RBO009 5SXS	Rear cage, cross diagonal and harness bar	€ 496,31
		RB00A1	Universal door bar (1 required per side)	€ 65,00
More information				

Make	Model	Part number	Description	Euro
VAUXHALL OPEL	Frontera Sport (also known as Isuzu Amigo) 	O 049	6-point bolt-in cage. Front cage clears dashboard and most trim. Single unique door bars. MSA/FIA homologated.	
		RBO049 3SSU	Front cage	€ 335,40
		RBO049 5SSU	Rear cage, single fixed diagonal	€ 485,56
		RBO049 5SXU	Rear cage, cross diagonal and harness bar	€ 615,56
		RBO049 DSUN	Single door bar N/S (left)	€ 90,02
		RBO049 DSUO	Single door bar O/S (right)	€ 90,02
More information				
VAUXHALL OPEL	VX220 	O 066	6 point bolt-in cage. Front cage with single roof diagonal or roof cross. Rear cage replaces original roll hoop. Rear cage has cross diagonal and harness bar. Existing seat belt arrangement can be retained. Front cage mounts to sills. Trim and body work modifications required. Not a DIY fit. MSA/FIA homologated. Door bars are not required with this cage, but if desired, RB00A3 universal door bars can be added (please note it may be awkward to get in to the car with door bars fitted due to the sill height).	
		RBO066 3SSS	Front cage with single roof diagonal. Please specify right hand drive or left hand drive when ordering.	€ 357,00
		RBO066 3SXS	Front cage with roof cross. Not suitable for taller drivers - head clearance may be an issue.	€ 441,00
		RBO066 5SXS	Rear cage, cross diagonal, harness bar	€ 693,00
		RB00A3	45mm/38mm universal door bar (not required, optional, if desired).	€ 67,51
More information				